

SHIPPING INDUSTRY GUIDANCE ON PILOT TRANSFER ARRANGEMENTS

ENSURING COMPLIANCE WITH SOLAS



International Chamber of Shipping



International Maritime Pilots' Association

Also supported by

IGP&I  BIMCO  INTERCARGO  INTERTANKO

 IPTA  CLIA  OCIMF  SIGTTO  ITP  IFSM  The Nautical Institute

SHIPPING INDUSTRY GUIDANCE ON PILOT TRANSFER ARRANGEMENTS

ENSURING COMPLIANCE WITH SOLAS

The following guidance has been produced by the International Maritime Pilots' Association (IMPA) in collaboration with the International Chamber of Shipping (ICS).

GENERAL

Pilots come aboard ship to assist the crew during the most critical and potentially hazardous phases of a voyage. Qualified pilots possess particular local knowledge and have the necessary ship-handling skills to assist the safe arrival and departure of vessels.

Normally, pilots board and disembark using a traditional rope ladder from and to a pilot boat. However, this can be a very dangerous procedure if those involved do not adhere to International Maritime Organization (IMO) standards or fail to practise acceptable seamanship skills.

A number of pilots have died as a result of accidents while boarding/disembarking from ships, and many more have been seriously injured.

Furthermore, deficiencies with regard to boarding arrangements and unsafe rigging of pilot ladders continue to be detected during port state control inspections, resulting in delays and financial penalties for the ship operator.

Nevertheless, pilot ladders remain the most safe and efficient way to board ships at sea and there is usually no alternative, except on occasions when a helicopter is used.

The following guidance is intended to remind seafarers and shipping companies of the vital importance of adhering to the rules and established procedures concerning the provision of safe boarding arrangements for pilots.

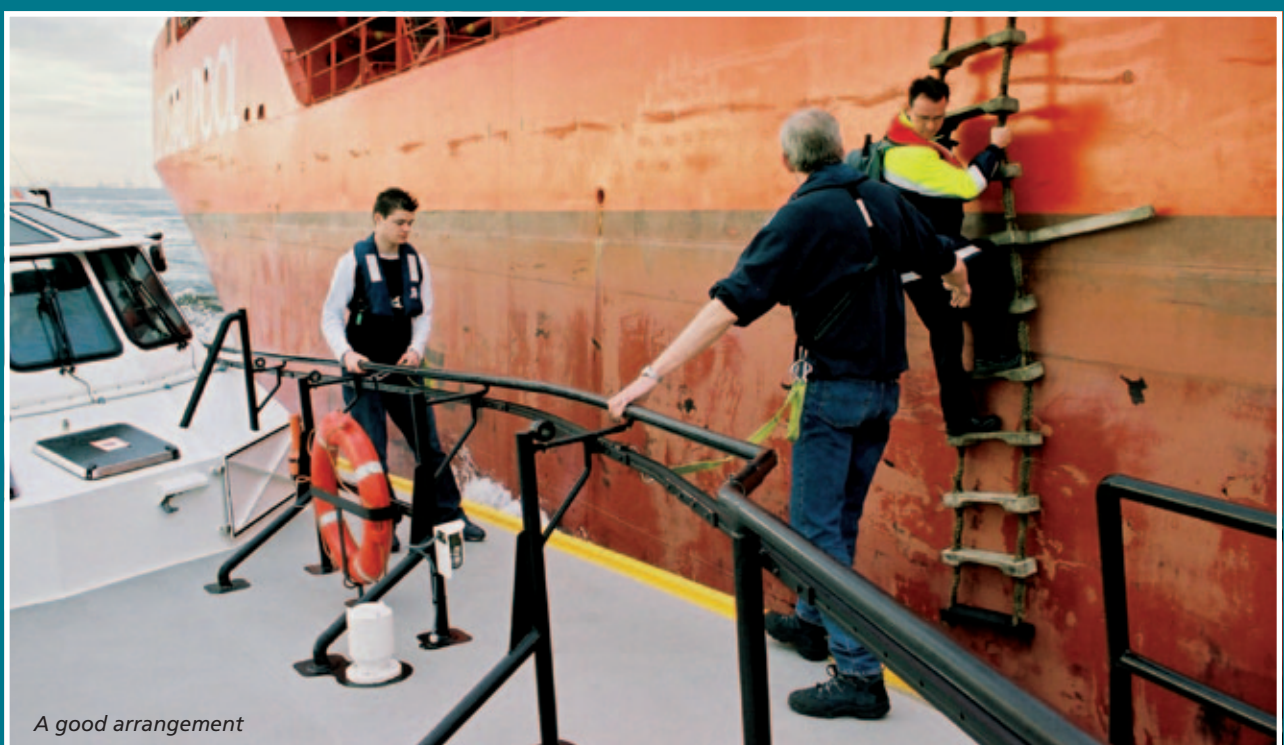

A good arrangement

ENSURING SAFE RIGGING FOR PILOTS

The IMO Convention for Safety of Life at Sea (SOLAS Chapter V, Regulation 23) sets out the principal requirements for the rigging of pilot ladders.

These provisions are set out in the diagram contained in this brochure. This diagram can be downloaded at www.impahq.org (on home page, click 'Downloads'). It is also reproduced in the ICS Bridge Procedures Guide.

There is further detailed technical specification for pilot ladders in IMO Resolution A.1045(27). Shipping companies have a legal obligation to provide a conforming ladder and ship-borne fittings. If seafarers are uncertain about any of the requirements, they should always ask their supervising officer for advice.

The two major causes of accidents are defects in the ladder treads or sideropes (see diagram) or a lack of proper attachment of the ladder to the vessel.

Seafarers should always check the condition of the ladder before it is rigged and also ensure it is secure to the ship. Whilst this is done, seafarers should always take care of their own safety, wearing a life jacket (and a life-line if appropriate).



Poor and incorrect securing method

MANAGEMENT ISSUES

Shipping companies should ensure that:

- Ladders are SOLAS compliant
- The inspection regime and records are adequate
- Replacement ladders are quickly and readily available on board
- Seafarers involved receive the necessary training and have a full understanding of the requirements.

IMPA is able to provide an advice document for new construction designs.

ON BOARD ISSUES

The Master and officers should:

- Closely supervise the rigging of pilot ladders
- Closely observe the shipping/landing of pilots from ladders, ensuring that SOLAS requirements are met
- Maintain a lee until the pilot vessel is well clear.

At all times during the rigging, use and de-rigging of any pilot transfer arrangements there should be no risk to the ship's crew. Crew members should not normally be required to leave the protection of the ship's safety rails or bulwarks. A life line or safety harness should be worn if there is any risk of falling.

NEW SOLAS REQUIREMENTS FROM 1 JULY 2012

Ships constructed after the 1 July 2012 must comply with the new equipment and arrangement requirements of SOLAS Regulation V/23. Equipment and arrangements replaced on or after the 1 July 2012 on existing ships, shall, so far as reasonable and practicable, comply with the requirements of this regulation.

These requirements include the securing of an accommodation ladder to the ship's side, when used in conjunction with the pilot ladder, and the prohibited use of mechanical pilot hoists.

SUMMARY

Pilots have the right to decline to board vessels offering defective ladders, which can result in serious delay. Pilots are also entitled to report defects in boarding ladders to port state control authorities, which could lead to a full PSC inspection with the risk of delay and financial penalties.

A pilot who has climbed a sound ladder, well rigged, and attended by an officer and a deck party will be in the right frame of mind to give his best attention to the safety of the vessel.

REQUIRED BOARDING ARRANGEMENTS FOR PILOT



In accordance with SOLAS Regulation V/23 & IMO Resolution A.1045(27)

INTERNATIONAL MARITIME PILOTS' ASSOCIATION

H.Q.S. "Wellington" Temple Stairs, Victoria Embankment, London WC2R 2PN Tel: +44 (0)20 7240 3973 Fax: +44 (0)20 7210 3518 Email: office@impahq.org

This document and all IMO Pilot-related documents are available for download at: <http://www.impahq.org>



RIGGING FOR FREEBOARDS OF 9 METRES OR LESS

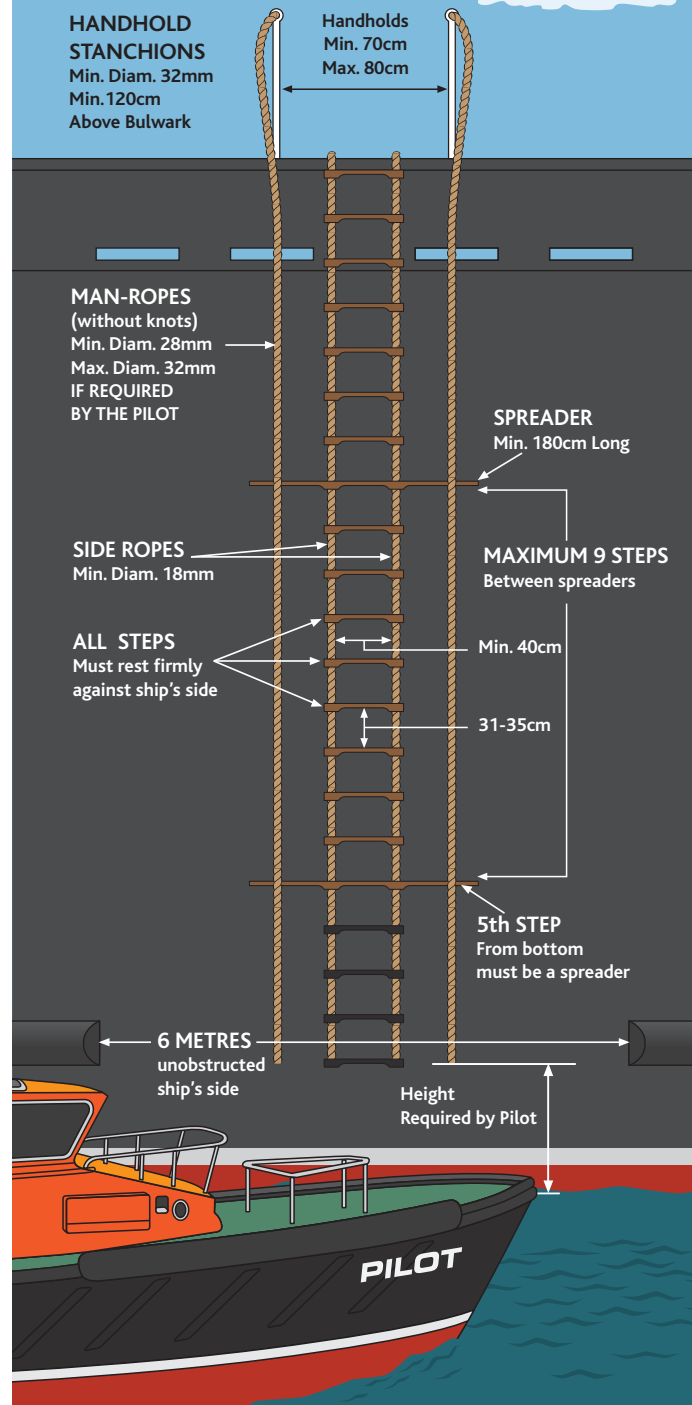

COMBINATION ARRANGEMENT FOR SHIPS WITH A FREEBOARD OF MORE THAN 9 METRES WHEN NO SIDE DOOR AVAILABLE

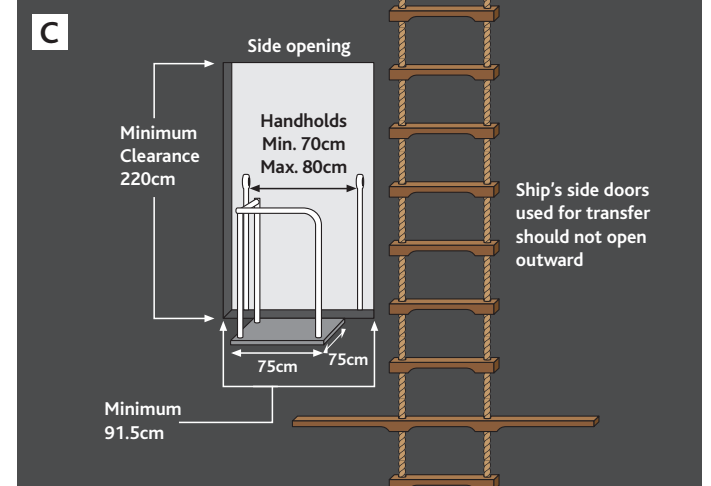
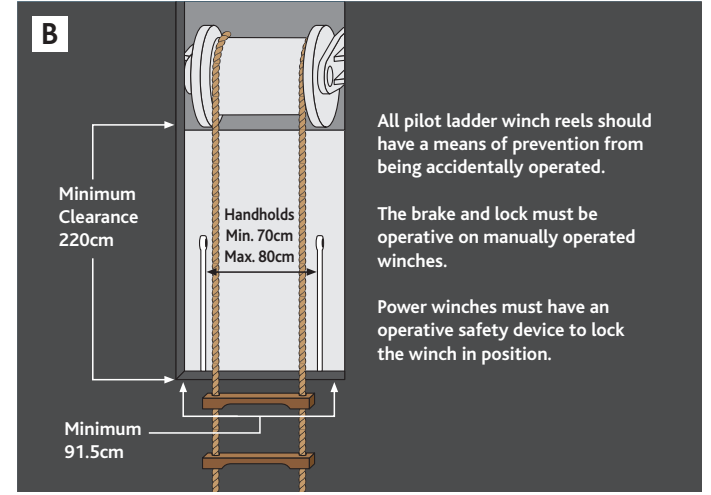
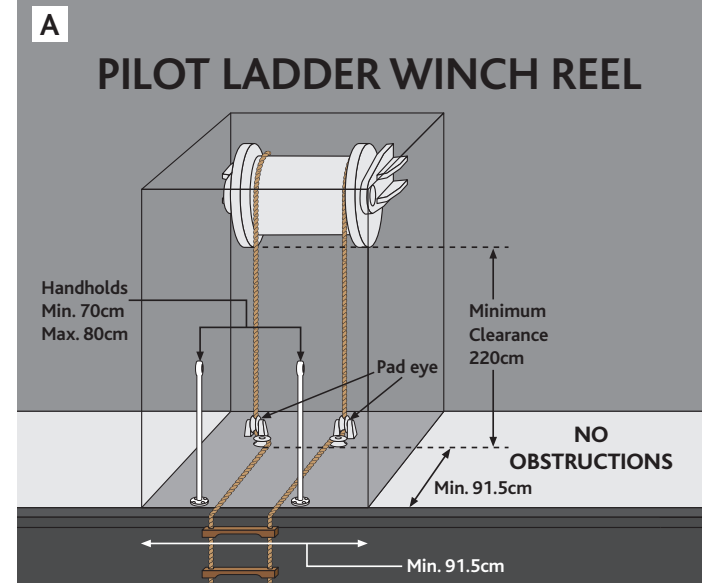
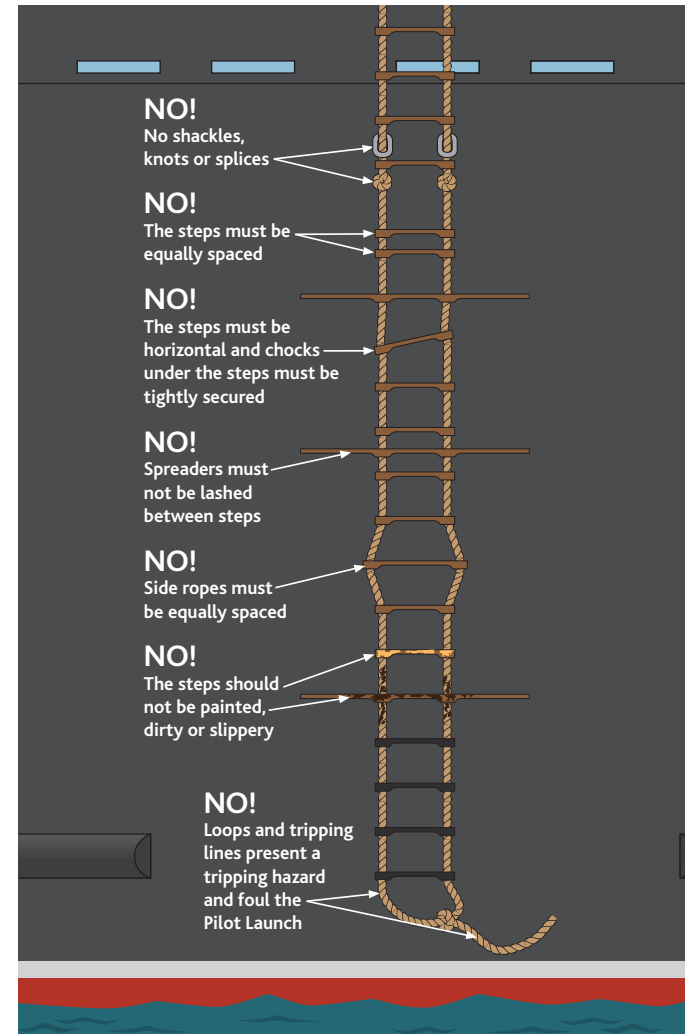
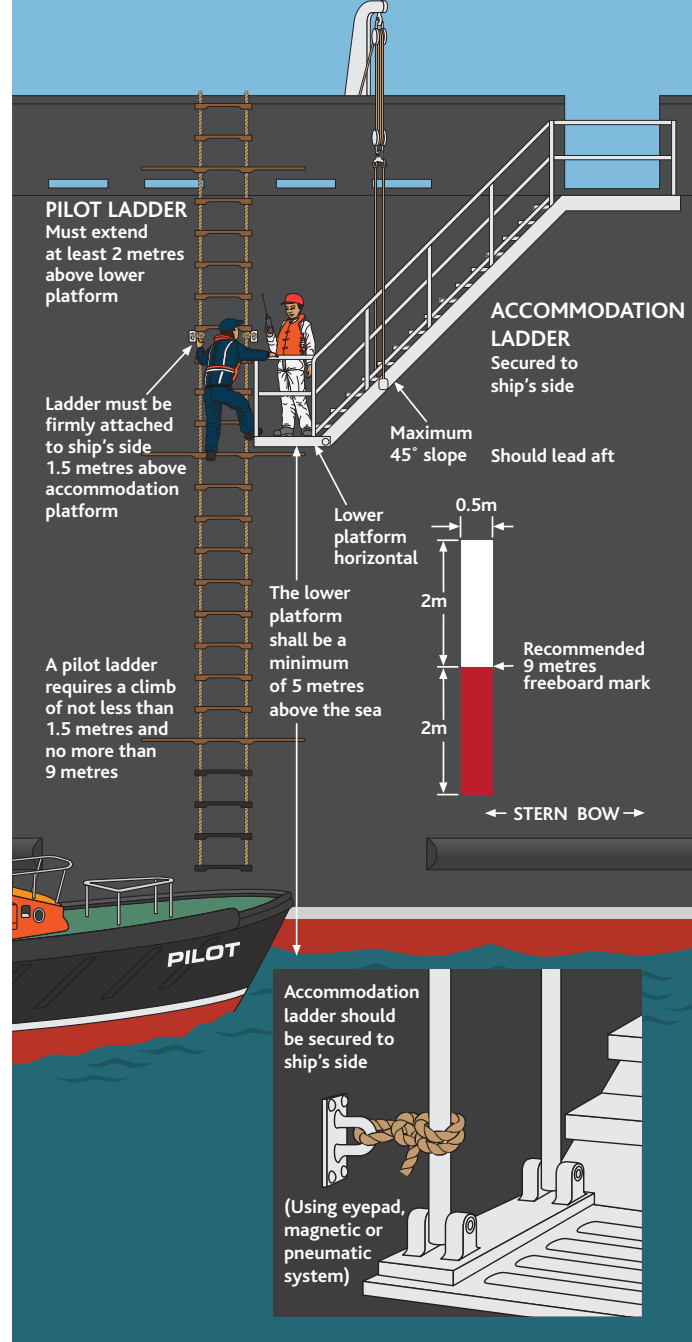

DISCLAIMER

These Guidelines have been developed using the best information available, but they are intended for guidance only, to be followed at the users' own risk. No responsibility is accepted by any firm, corporation or organisation who or which has been in any way concerned with the furnishing of data, the compilation, publication or authorised translation, supply or sale of this guidance, for the accuracy of any information or advice given herein, or any omission herefrom or consequences whatsoever resulting directly or indirectly from use of these guidelines or from compliance with or adoption of guidance contained therein.

SHIPPING INDUSTRY GUIDANCE ON PILOT TRANSFER ARRANGEMENTS

ENSURING COMPLIANCE WITH SOLAS

1st Edition 2008

2nd Edition 2012

Published by

Marisec Publications
38 St Mary Axe
London, EC3A 8BH

Tel +44 20 7090 1460
Fax +44 20 7090 1484
publications@marisec.org

www.ics-shipping.org

An electronic version of this leaflet is available at:

www.ics-shipping.org/pilotladders and www.impahq.org/downloads.cfm

© Maritime International Secretariat Services Limited 2012



International Chamber of Shipping



International Maritime Pilots' Association

Also supported by

IGP&I



BIMCO



INTERCARGO



INTERTANKO

IPTA



SIGTTO

